

LABOR NEW



MODELS	
70	RV TN
70	RS/RV TB











ISA S.r.l.
Via del Lavoro, 5
06083 Bastia Umbra - Perugia - Italy
Tel. +39 075 80171 - Fax +39 075 8000900
www.isaitaly.com



CONTENTS

1. NOTES / IMPORTANT NOTES	4
1.1 Introduction	5
1.2 Manufacturer's contact details.	5
2. SAFETY	6
2.1 Personnel training.	6
2.2 Safety devices applied	6
2.2.1 Safety devices present	6
2.2.2 Fixed protective devices	6
2.2.3 Sectioning the electrical power supply.	7
2.3 Residual risks	7
2.3.1 Risk of contact with parts under stress	7
2.3.2 Fire.	7
2.3.3 Explosive atmosphere	8
2.3.4 Slipping.	8
2.3.5 Tripping.	8
2.3.6 Circuit faults	8
2.4 Warning signs (if any)	8
3. WASTE DISPOSAL	9
4. INSTALLATION	10
4.1 Storage and unpacking	10
4.2 Installation, positioning and ambient conditions	10
4.3 Electrical connection	10
5. TECHNICAL SPECIFICATIONS	11
5.1 Installation	12
5.2 Positioning	13
5.3 Load limits	13
6. EQUIPMENT DESCRIPTION	14
6.1 Structure	14
6.2 Identification	14
7. CONTROL PANEL	15
7.1 User Interface.	16
8. ROUTINE MAINTENANCE AND REGULAR CHECK	18
8.1 Chiller compartment inside cleaning	18
8.2 Accessing and cleaning the condensing unit	18
8.3 External cleaning operations.	18
9. MAINTENANCE	19
10. TECHNICAL ASSISTANCE CENTRE	20
10.1 Faults.	20
10.2 List of alarms on the electronic controller (if any)	21
11. WARRANTY TERMS AND CONDITIONS	21
12. ATTACHMENTS	22

The manual contains symbols to attract the reader's attention and highlight particularly important aspects. The table below illustrates the meaning of the various symbols used.

	Read the instructions manual
	Use of protective clothing
	Danger: Live electric parts
	Request of maintenance or operations to be carried out by qualified personnel or technical assistance centre
	Attention / Danger
	Important information
	Information
	Operations to be performed by two persons
	Visual check
	Notes / Warnings

1. NOTES / IMPORTANT NOTES



The content of this manual is of technical nature and is owned by **ISA S.r.l.**. It is forbidden to reproduce, circulate or modify all or part of its content without written consent. Any infringement will be legally pursued.

The manual and the conformity certificate are an integral part of the equipment and should always accompany the product in the event of transferral to a new location or to a new owner. The user is responsible for the integrity of these documents, for their consultation during the whole life cycle of the equipment itself. Keep this manual in a safe place. It should be made available near the equipment for consultation at any time. If lost or destroyed, you can request a copy of the manual to **ISA S.r.l.** by specifying the exact model, identification number and year of manufacturing. The manual reflects the manufacturing technology at the time of supply. The manufacturer reserves the right to modify its products in any way it deems necessary, with no obligation to update manuals and machines relating to previous manufacturing batches.

This equipment is not intended for use by persons (including children) with reduced physical, sensory or mental capabilities or by persons lacking the necessary experience and knowledge, unless they are supervised by a person responsible for their safety who has instructed them on how to use the cabinet. Children should be supervised to ensure that they do not play with the equipment. Always refer to this manual before going ahead with any operation. Before doing any type of work, disconnect the equipment from the power supply. Any work on electric and electronic parts or cooling system components should only be carried out by trained personnel in compliance with current laws.

The Manufacturer cannot be held liable for any injury to persons or animals, or damage to the product itself in the event of:

- Improper use of the equipment or use of the appliance by unqualified or unauthorised personnel.
- Failure to comply with current legislation.
- Incorrect installation and/or power supply faults.
- Failure to observe the instructions contained in this Manual.
- Failure to follow the maintenance programme.
- Unauthorised modifications.
- Installation of non-original spare parts in the equipment.
- Installation and use of the equipment for purposes other than those for which the appliance was designed and sold.
- Tampering with or damage to the power supply cable.

Liability for applying the safety instructions contained in this manual is held by the technical personnel responsible for the intended use of the equipment, who should ensure that authorised personnel:

- Are qualified to carry out the requested activity.
- Are aware of, and carefully comply with, the instructions contained in this document.
- Are aware of, and apply, the general safety standards applicable to the equipment.

Failure to comply with safety standards may result in injury to personnel and damage to the equipment components and control unit. The user can contact the dealer to request additional information not contained in this document, or suggest improvements, at any time.



Before the product is delivered to the customer, it is essential that a trained technical member of staff checks that the equipment is operating correctly in order to achieve maximum performance.

1.1 Introduction

ISA S.r.l. employs materials of the best quality and as they enter the company, we constantly monitor their storage and the use as part of the manufacturing process to prevent damage, deterioration and failure. All manufacturing elements are designed and manufactured in order to guarantee reliability and high safety standards. All equipment is subjected to a strict testing procedure before delivery. However, please bear in mind that product performance over time depends on correct use and adequate maintenance. This manual contains the necessary instructions to maintain the equipment's initial appearance and functions over time.



Note

So as not to compromise equipment operation and safety, particularly complex installation and maintenance operations are not described in this manual and are carried out by the manufacturer's specialised technical personnel.

The Use and Maintenance Manual contains the necessary information for understanding how the equipment works and how to use it properly, namely: the technical description of the various operational units, equipment and safety systems, operations, how to use the instruments and the interpretation of any diagnostics reports, main procedures and information relating to routine maintenance. For correct use of the equipment, the working environment should comply with current health and safety standards.

The safety requirements, indications, standards and notes illustrated in the various chapters of this manual are aimed at establishing a code of conduct and a series of obligations to be observed when performing the various activities, in order to create safe conditions for personnel, the equipment and the surrounding environment. The safety standards reported in this document are intended for trained, authorised personnel responsible for:

- Transport
- Installation
- Operation
- Management
- Maintenance
- Cleaning, decommissioning and disposal which are the only intended uses of this equipment



Attention

Reading this manual, albeit in full, is no substitute for adequate user experience. therefore it should only be considered a useful reminder of the technical features and the main operations to perform.



Warning

Installers and users are obliged to read and understand all the instructions contained in this document before using the equipment.

1.2 Manufacturer's contact details

ISA S.r.l.

Via del Lavoro, 5
06083 - Bastia Umbra - Perugia - Italy
Tel. +39 075 80171
Fax +39 075 8000900

www.isaitaly.com

2. SAFETY

The buyer is responsible for training personnel using the appliance on the risks, safety devices and general health and safety rules required by the laws of the country where the equipment is installed.

Users/operators should be aware of the position of all the controls and how they work, as well as of the features of the equipment.

They should also read this manual in its entirety.

Maintenance work should be conducted by qualified personnel after the equipment has been prepared adequately.



Danger

Tampering with or unauthorised replacement of one or more parts of the equipment, applying accessories that modify its use and fitting spare parts other than recommended ones may result in accident risks.



Danger

Before doing any type of work, the equipment must always be disconnected from the power supply.

Any work on electric parts or cooling system components should only be carried out by trained personnel in compliance with current laws.

2.1 Personnel training

The buyer is responsible for ensuring personnel who will use the equipment and maintenance technical staff are instructed and trained adequately.

The manufacturer is available for advice, clarifications, etc. so that the operator and technical staff can use the equipment correctly.



Attention

The equipment is intended for professional use.

2.2 Safety devices applied

The Equipment is equipped with the following safety devices:

2.2.1 SAFETY DEVICES PRESENT

2.2.2 FIXED PROTECTIVE DEVICES

2.2.3 SECTIONING THE ELECTRICITY SUPPLY

2.2.1 Safety devices present

Devices which operation prevents risk situations in operation conditions verifying (e.g. fuses, pressure switches, protective devices, circuit breakers, etc.).

2.2.2 Fixed protective devices

Fixed protective devices consist of fixed perimeter shields, which are used to prevent external parts from entering the equipment.



Danger

It is strictly forbidden to start up the equipment after maintenance work without refitting the panelling properly.



Attention

You should check the integrity of fixed panels and corresponding fixings to the frame, focusing in particular on the protective panels.

2.2.3 Sectioning the electricity supply

Before conducting any maintenance work on the equipment or part of it, it is necessary to section the power supply that powers it.



Danger

Please remember to fully disconnect the equipment from the power supply in the event of maintenance work during which the operator cannot prevent any accidental closure of the circuit by other people.

2.3 Residual risks

During design the manufacturer examined all the areas or parts at risk. Therefore, all necessary precautions have been taken to prevent risks to persons and damage to the equipment as mentioned earlier.



Attention

Periodically check that all safety devices are operating correctly.
Do not remove the fixed protective devices.
Do not introduce foreign objects or tools into the operational and working area.

Although the equipment is fitted with the aforementioned safety devices, there are still some risks that cannot be eliminated, but reduced via corrective actions by the final integrator and correct operational procedures.

Below is a summary of the remaining risks associated with the equipment during:

- Normal operation
- Adjustments and tweaking
- Maintenance
- Cleaning

2.3.1 Risk of contact with live parts

Risk of breaking or damaging the electrical components of the equipment, with a possible reduction in safety levels, following a short circuit.
Before connecting the electricity supply, make sure there is no ongoing maintenance work.



Attention

Before making the connection, check that the d/c electricity at the point of installation is no higher than the value indicated on the protective switches on the fuse box. If it is, the user is responsible for fitting the relevant limiting devices.
It is strictly forbidden to conduct any electrical modification, in order to prevent additional unforeseen hazards and risks.

2.3.2 Fire



Danger

In the event of a fire, immediately disconnect the master switch from the main power supply line.

2.3.3 Explosive atmosphere

The equipment must not be located in an area classified as an explosion risk according to 1999/92/EC such as:

Zone 0

An area in which there is a permanent, long-lasting or frequently explosive atmosphere made up of a mixture of air and flammable substances in the form of gases, fumes or steam.

Zone 1

An area in which the formation of an explosive atmosphere, made up of a mixture of air and flammable substances in the form of gases, fumes or steam is occasionally probable during normal activities.

Zone 20

An area in which there is a permanent, long-lasting or frequently explosive atmosphere in the form of clouds of combustible dust in the air.

Zone 21

An area in which the formation of an explosive atmosphere in the form of clouds of combustible dust is occasionally probable during normal activities.

2.3.4 Slipping



Any leaks in the areas surrounding the equipment may cause personnel to slip. Check that there are no leaks and keep these areas clean at all times.

2.3.5 Tripping



Generally untidy deposits of material may constitute a tripping hazard and a total or partial obstruction of emergency exit routes. You should ensure that operating and transit areas and emergency exit routes are free from obstacles in compliance with current legislation.

2.3.6 Circuit faults

Owing to potential faults, safety circuits may become less effective, which results in lower safety levels.

You should check the operational condition of the present safety devices regularly.

2.4 Warning signs (if any)

Owing to the presence of various residual risks identified, the equipment is fitted with hazard, warning and obligation signs devised in compliance with regulations relating to graphical symbols for use on systems.

The signs are located in clearly visible positions.



Attention

It is strictly forbidden to remove the warning signs on the equipment.

The user is responsible for replacing warning signs that, owing to wear, become unreadable.

3. WASTE DISPOSAL

During normal operation, the equipment does not generate any environmental contamination. At the end of its life cycle, or if it is necessary to proceed to permanent decommissioning, we recommend following the procedures below:

DISPOSAL (User)



The symbol, applied to either the product or its packaging, indicates that the product should not be considered as normal domestic waste, but should be taken to a waste collection point for the recycling of electrical and electronic appliances. The correct disposal of this product helps to prevent potential negative consequences that might derive from inadequate product disposal. For detailed information about recycling this product, contact your council, your local waste collection service or the store where you purchased the product.

END-OF-LIFE DISPOSAL AND RECYCLING PROCEDURES FOR THE EQUIPMENT (Authorised Bodies)

1. Switch off the equipment and unplug the power supply cable.
2. Remove the lamps (if installed). These should be disposed of separately.
3. Remove the control boards and the electronic cards. These should be disposed of separately.
4. Remove all the independent parts (grids, casings, profiles, etc.) and group them according to shared features in order to access the heat exchangers, pipes, cables, etc. and be careful not to damage the cooling circuit.
5. Remove all mobile parts (doors, sliding doors, glass parts, etc.) and group the various materials according to their features.
6. Check the type of coolant on the label located inside the counter. Remove the coolant and dispose of it through authorised services.
7. Disconnect the evaporator, condenser, compressor, pipes and fans. These are made of copper, aluminium, steel and plastic and should therefore be disposed of separately.
8. Once all the guardings and the various parts of the frame have been removed, separate the various types of material they are made from (plastic, metal sheets, polyurethane, copper, etc.) into groups according to their features.



All recyclable materials and waste should be processed and recycled by professionals, in compliance with the laws of the country in question. The company responsible for recycling the materials should be registered and certified as a waste disposal service in accordance with the specific directives of the country in question.



Attention

Illegal disposal of the product by the owner will result in administrative sanctions as required by current laws. Disposal of the product should comply with current laws on the disposal of coolant liquids and mineral oils.



Important

If there is no symbol representing a barred dustbin on the equipment, this means that the manufacturer is not responsible for taking care of the disposal of the product. In this case, again, current waste disposal laws should be complied with.



Additional information

Further information on the disposal of liquid coolant, oils and other substances is available on the safety data sheet corresponding to the substance itself.

4. INSTALLATION

This manual provides information on how to unpack, position and connect to the power supply.

4.1 Storage and unpacking

The equipment, with or without the packaging, should be carefully stored inside warehouses or in areas away from the elements and direct sunlight, at a temperature between **0** and **+40°C**.



The equipment should only be moved by qualified personnel operating forklift trucks, the power of which should be suited to handling the weight of the product: during this operation the equipment **MUST** be placed on the special pallet supplied.

Unpack the equipment by removing the screws fixing it to the pallet. All packaging materials are recyclable and should be disposed of in accordance with local regulations. Please destroy "plastic" bags to prevent them from becoming hazardous to children (suffocation).

4.2 Installation, positioning and ambient conditions



Attention

There should be a good air flow around the compressor and condensing unit. Therefore the area around the unit should not be obstructed by boxes or other objects. Position the equipment away from sources of heat (radiators, all types of ovens, etc.), and away from draughts (generated for example by fans, air conditioning ducts, etc.). Also avoid direct exposure to sunlight, or anything that causes the temperature inside the cabinet to rise with detrimental results to unit operation and energy consumption. Do not use the equipment outdoors and do not leave it exposed to rain.

4.3 Electrical connection



Attention

Check that the voltage indicated on the appliance is the same as the value on the appliance identification label and in the table provided in paragraph 2 of this manual, and check that the required voltage is suitable. Check on the socket that the power supply voltage provides rated voltage ($\pm 10\%$) when the compressor is started. The plug should be directly connected to the electrical socket. It is forbidden to connect the plug to the socket by means of multiple socket extensions or adaptors. The electrical system socket must be fitted with a disconnecting device from the mains (rated for the load and conform to current standards) to guarantee full disconnection in overloads category III (3) and ensure protection of the circuits from earth faults, overloads and short circuits. Do not route the electricity cable in passageways.



Attention

Earthing is necessary and mandatory by law.

5. TECHNICAL SPECIFICATIONS

This equipment is exclusively intended to preserve:

- TN:** pre-packaged fresh products.
- TB:** ice creams and/or frozen food.

The manufacturer is not liable for injury to persons or damage to property or the equipment itself caused by the displaying of products other than those described above.



Unauthorised use:

- Food preservation.
- Displaying and/or preserving non-food products (chemicals, pharmaceuticals, etc).

RV TN

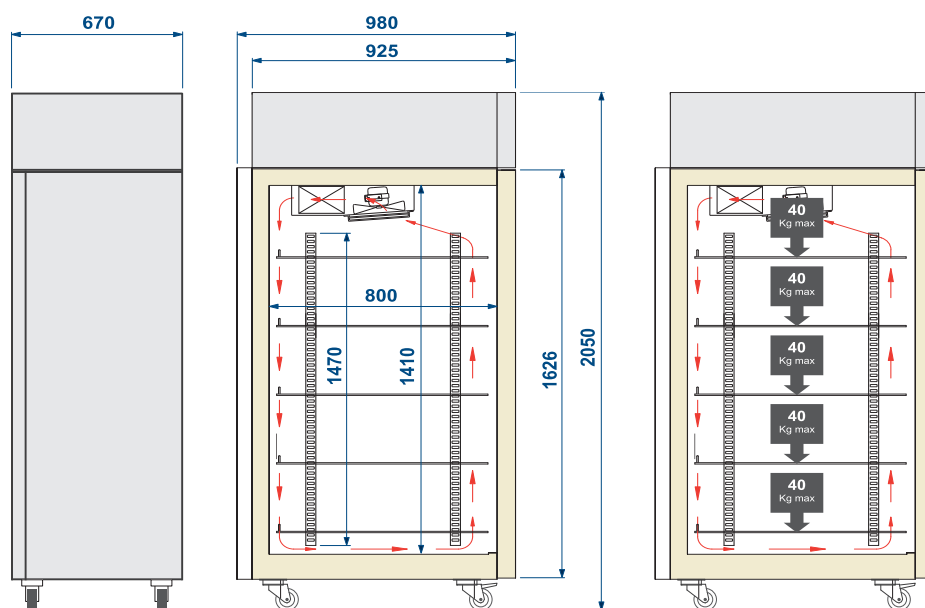

RS/RV TB

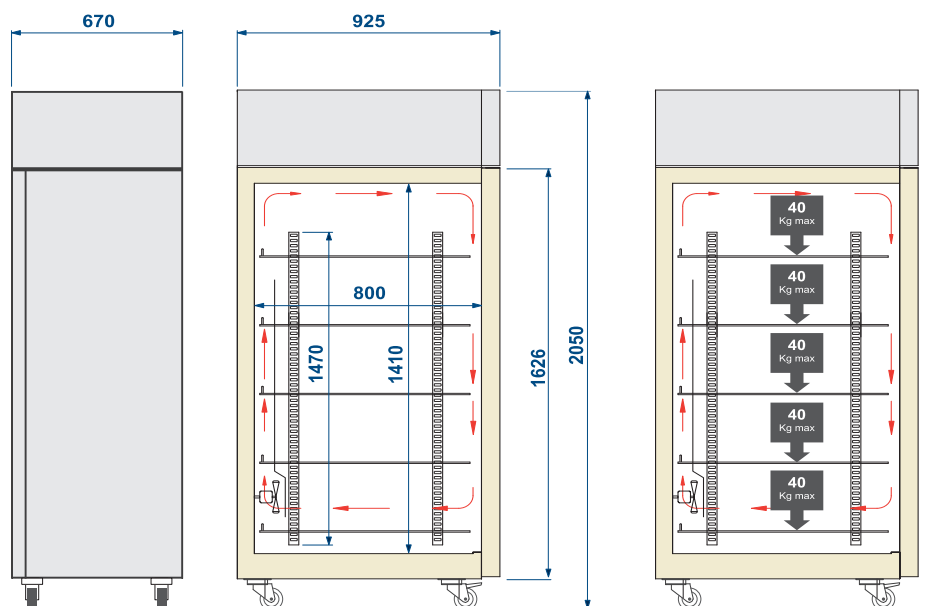

TECHNICAL FEATURES		70	70
		RV TN	RS/RV TB
External dimensions (wxdxh)	mm	670 x 980 x 2050	670 x 925 x 2050
Refrigeration		Ventilated	Ventilated
Defrosting		Compressor Stop	Manual
Climate class	No.	4	4
Environmental conditions	°C / % RH	30 / 55	30 / 55
Product class		-	-
Safety class (CEI EN 60335-2-89)	No/°C (environment)	5 / 43 ± 2°C	5 / 43 ± 2°C
Refrigerant		R404A	R404A
Power supply	V / ph / Hz	230 / 1 / 50	230 / 1 / 50
Electric absorption (at rated capacity)	W / A	300 / 1.9	560 / 3.9
Electric absorption (during defrosting)	W / A	-	-
Weight (net)	Kg	148	148

5.1 Installation (Technical dimensions mm)



Attention

The distances indicated for correct equipment installation must be respected.

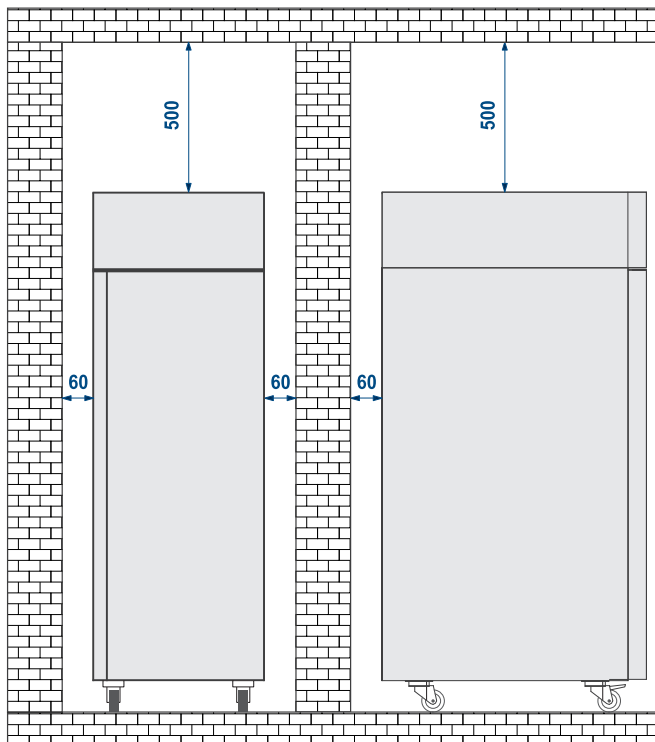

5.2 Positioning



Warning

The equipment is fitted with swivel wheels (two with brake) for easy manoeuvrability. It is absolutely necessary after placement, to stabilise the equipment to the floor.

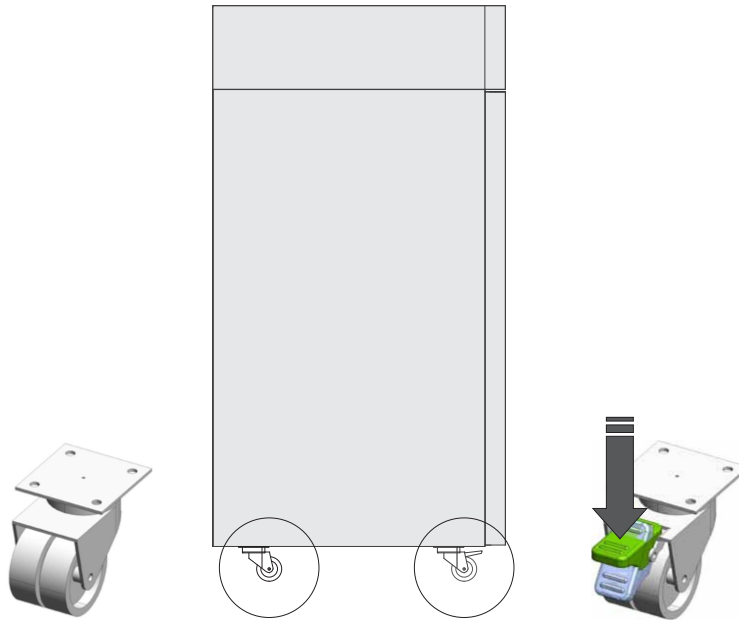

5.3 Load limits



Attention

It is essential not to exceed the indicated load limits in order to prevent altering the correct air flow and thus avoid higher product temperatures.



6. EQUIPMENT DESCRIPTION

To ensure the operator's safety, equipment devices should be kept in constant working order. This manual is intended to illustrate the use and maintenance of the equipment. The operator has a responsibility and duty to carefully observe its instructions.

6.1 Structure

The equipment consist of a single piece of furniture which contains all the operational devices necessary to make it a professional and efficient product for its intended use.

The equipment consists of:

- Insulated structure in ecological polyurethane
- Cooling system
- Electronic commands panel
- Electrical system
- On board condensing unit
- Hinged door
- Swivel wheels with blocking brake
- Key lock



6.2 Identification

1: Symbols of Compliance

2: Identification of Company Product Manager

3: Production Order

4: Type

5: Model Name

6: Article

7: Serial Number

8: Production Date

9 - 10: Power supply Voltage and Frequency

11: Gross Capacity

12: Absorption at Rated Capacity

13: Absorption during Defrosting

14: Absorption of Heating Elements

15: Lamp Power

16: Fuse Value

17: Climate Class

18: Number of Motors

19: Type of Coolant

20: Amount of Coolant

21: Safety Class

22 - 23: Customer order

24: WEEE Mark

1	Symbols of Compliance
2	Identification of Company Product Manager
3	Production Order
4	Type
5	Model Name
6	Article
7	Serial Number
8	Production Date
9 - 10	Power supply Voltage and Frequency
11	Gross Capacity
12	Absorption at Rated Capacity
13	Absorption during Defrosting
14	Absorption of Heating Elements
15	Lamp Power
16	Fuse Value
17	Climate Class
18	Number of Motors
19	Type of Coolant
20	Amount of Coolant
21	Safety Class
22 - 23	Customer order
24	WEEE Mark

7. CONTROL PANEL

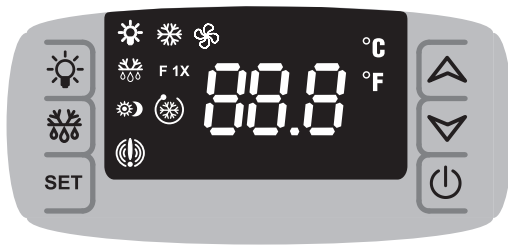

Attention

The electronic control board is installed already programmed. Any changes to the control board settings can be carried out exclusively by qualified technical personnel.

7.1 User Interface



KEYS - Single Pressing		KEYS - Combined Pressing	
	Switches lighting on or off.		To lock and release keyboard.
	SBR To start defrosting.	SET +	To access programming.
SET	To display or modify set-point. Selects a parameter or confirms a value when in programming.	SET +	To exit programming.
	UP Scrolls parameters' codes or increases their value when in programming. Activates the Continuous cycle function when present.		
	DOWN Scrolls parameters' codes or decreases their value when in programming. Activates the High and Low Humidity function when present.		
	Switches instrument on or off.		

LED	Mode	Meaning
	On	Compressor(s) active
	Flashing	Delay against close start-ups
	On	Defrosting in progress
	Flashing	Dripping in progress
	On	A temperature alarm has occurred
	On	Continuous cycle in progress
	On	Energy saving in progress
°C / °F	On	Unit of measure
	Flashing	Programming

Functions

Minimum temperature display

Press and release key .

The "Lo" message is displayed followed by reached minimum temperature.

Press  or wait 5 seconds to go back to displaying normal temperature.

Maximum temperature display

Press and release key .

The "Hi" message is displayed followed by reached maximum temperature.

Press  or wait 5 seconds to go back to displaying normal temperature.

Set Point display



Press and release **SET**, set point is immediately displayed.

Wait 5 seconds or press key again, to go back to temperature display **SET**.

Set Point modification

Press **SET** for at least 2 seconds.

Set point is displayed and LED °C starts flashing.



Modify value by acting on keys  and .

Memorise new set point by pressing **SET** or wait 15 seconds to exit programming.

Manual defrosting



Press  for at least 2 seconds to start defrosting cycle.

Keyboard lock

Keep both keys   pressed for a few seconds until "POF" appears flashing. The keyboard is now locked; only display of set point, maximum and minimum temperature is possible.

"POF" appears if a key is pressed for more than 3 seconds.

Keyboard release

Keep both keys   pressed for a few seconds until "POn" appears flashing.

On / Off

Press  for 2 seconds for display to show "OFF".

Loads and all adjustments are disabled in this configuration.

Press key again for 2 seconds to bring instrument at ON again.

8. ROUTINE MAINTENANCE and REGULAR CHECK

8.1 Chiller compartment inside cleaning

- a)
Remove the product contained in the chiller compartment and place it immediately in a freezer to ensure it is preserved correctly.
- b)
Switch off the equipment. Wait at least 4 to 6 hours, until the ice on the evaporator has melted completely, before proceeding with cleaning the equipment.
We recommend waiting until the following day to make sure the product has been completely defrosted.
- c)
Wash the bottom of the tank and the sides with a mild detergent, warm water and a cloth or a non-abrasive sponge. Rinse well and dry using a cloth.
- d)
If the equipment is connected with a ground discharge, pour some warm water with a sanitising solution suited for the intended use. In terms of quantity, the amount of solution used should be enough to remove any product residues and disinfect the whole drainage channel. If the equipment is not connected to a drain channelled into the ground, follow the procedure described in the previous paragraph. The water used to rinse the solution should be collected in the tray located inside the base of the equipment. Clean and disinfect the tray.

8.2 Accessing and cleaning the Condensing Unit

Remove the upper protective grid by loosening the specific fixing screws.

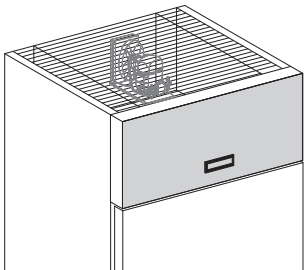

Attention

Clean the condensing unit using a suction brush.

Clean the **CONDENSING UNIT** using a soft bristle brush; make sure you do not bend the condensing unit springs whilst cleaning it.

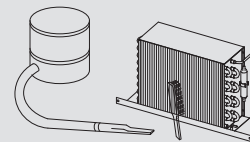

8.3 External cleaning operations

The external surfaces should be cleaned as follows:

STAINLESS STEEL

Wash with lukewarm water and mild detergents, rinse and dry using a soft cloth.

ACRYLIC OR POLYCARBONATE SURFACES

Wash with lukewarm water, using a soft cloth or a chamois cloth.
Do not use detergents, alcohol, acetone and solvents.
Do not use abrasive cloths or sponges.

GLASS SURFACES

Only use products specifically designed for cleaning glass.
We do not recommend using tap water, which may leave calcium deposits on the surface of the glass.

9. MAINTENANCE

Any work conducted on the on the equipment **MUST** involve disconnection from the power socket and in any case, none of the protective elements (grid, casing) should be removed by non-qualified staff; the equipment should not be operated when these protective elements have been removed.

The **Equipment manager** must check and respect the maintenance schedule in the table below by calling the authorised **Technical Assistance** service when indicated.

ROUTINE		
OPERATION	FREQUENCY	AUTHORISED PERSONNEL
Cleaning the external surfaces	Depending upon Use and Necessity	User
Cleaning the accessible internal parts (without the use of tools)	Depending upon Use and Necessity	User
Power supply cable, electric sockets and/or plugs check	Monthly/Six monthly	User
Check the seal gaskets integrity	Monthly	User
Condenser cleaning	Monthly/Six monthly	Technical Assistance
Check the compressor oil level (if present)	Six-monthly	Technical Assistance
Air tank draining (if present)	Six-monthly	Technical Assistance
Check pneumatic connections (if present)	Six-monthly	Technical Assistance
Check the integrity of chiller system piping	Six-monthly	Technical Assistance
Inspect cables and internal power connections	Six-monthly	Technical Assistance
Cleaning of condensation absorbing sponges (if present)	Six-monthly	Technical Assistance

EXTRAORDINARY	
OPERATION	AUTHORISED PERSONNEL
Replacing lamps/LED (if present)	Technical Assistance
Replacing control panel (electronic control board - thermostat - etc.)	Technical Assistance
Replacing power supply cable, electric sockets and/or plugs check	Technical Assistance

10. TECHNICAL ASSISTANCE

10.1 Faults

If the appliance is not working properly or stops working, **before contacting the Customer Support Centre**, check the following:

FAILURE	CAUSE	SOLUTION
The appliance is not working	Blown protective fuse	Find what triggered the switch and subsequently replace the fuse.
	The master switch is open	Close the master switch.
	Plug is not inserted	Insert the plug.
	Power cut	If the power cut persists, transfer the product to a freezer.
The internal temperature is not low enough	Evaporator(s) completely blocked by ice	Carry out an additional defrosting cycle.
	The wrong temperature has been set on the electronic control board	Set the right temperature.
	The equipment is affected by draughts or is exposed to direct or reflected sunlight	Eliminate any excessive draughts and prevent any direct or reflected sunlight.
	Insufficient cooling air flow in the air condensing unit	Remove anything that may affect air flow inside the condensing unit (paper sheets, cardboard, grids with an insufficient number of holes, etc.).
	The internal fans have stopped or their blades are damaged	Contact the Technical Assistance service.
	Internal ventilation is too high	Contact the Technical Assistance service.
	Low electronic control board efficiency	Contact the Technical Assistance service. Replace electronic control unit. Replace the temperature probes only after checking which of the two is not operating efficiently.
	Air condensing unit blocked by dust or debris	Contact the Technical Assistance service . Clean the condensing unit thoroughly.
	Insufficient coolant in the cooling system	Contact the Technical Assistance service Find the cause behind the lower amounts of coolant and eliminate it. Top up the coolant. If necessary, empty the system before topping up.
The compressor does not work or works only for a few moments	No power supply	Check if there is a power cut. Close the various switches on the power supply line.
	The power supply voltage is too low	Check that the mains voltage at the ends of the power supply cable is 220V +/- 10%.
	The temperature set on the thermostat is too high	If the set temperature is higher than that of the air in the display area, the compressor does not activate itself. Set a more suitable temperature if the current value is not low enough.
	The pressure switch (if any) was activated at maximum pressure	Contact the Technical Assistance service . Check the reasons why the pressure switch is operating at maximum pressure levels, such as: air condensing unit blocked, condensing unit fan stopped, ambient temperature too high, pressure switch broken.

10.2 List of alarms on the electronic controller (if any)



ALARM	DESCRIPTION	SOLUTIONS
P1 E0	Broken thermostat probe. Compressor trip with "CON" and "COF" parameters	Contact the Technical Assistance service . The alarm starts a few seconds after the probe breaks down; it stops a few seconds after the probe starts working again properly. We recommend checking the probe connections before replacing it.
P2 E1	Broken evaporator probe. Set time for defrosting	Contact the Technical Assistance service . The alarm starts a few seconds after the probe breaks down; it stops a few seconds after the probe starts working again properly. We recommend checking the probe connections before replacing it.
HA HI	High temperature alarm	Contact the Technical Assistance service . The alarm stops automatically after reaching of set temperature. Check the settings.
LA LO	Low temperature alarm	Contact the Technical Assistance service . The alarm stops automatically after reaching of set temperature. Check the settings.
EA IA CB	External alarm	Contact the Technical Assistance service . The external alarm stops after the digital infeed is deactivated. It should be automatically restarted. The alarm is activated when the pressure switch and/or the compressor's circuit breaker (if present) is activated.
ETc RTF	Real time clock is broken	Contact the Technical Assistance service . Reset the clock. If the alarm does not stop, replace the clock.
EE	Machine parameter error	Contact the Technical Assistance service . The instrument is damaged. It should be replaced.
EF	Operating parameters error	Contact the Technical Assistance service . The instrument is damaged. It should be replaced.

11. WARRANTY TERMS AND CONDITIONS



The seller's warranty on the equipment is valid for **12 (twelve) months from the date of delivery**.

The warranty includes repairs or replacements of any faulty parts due to manufacturing processes or installation after written communication has been received, stating the equipment serial number and date of installation.

All defects caused by incorrect use of the equipment, inappropriate electrical connection, normal wear (for instance compressor failure and fluorescent lamp malfunctioning that is not due to manufacturing defects), as well as calls for installation, technical instructions, adjustments and cleaning, are not included in the warranty.

If the seller's technical staff detect any tampering, unauthorised repairs or inappropriate use of equipment the warranty will be invalidated.

Shipment of components covered by the warranty is freight collect only.

Any damage to the equipment detected at the time of delivery due to transport must be reported on the same shipping note to claim compensation from the carrier.

The seller cannot be held liable in the event of damage to the preserved product due to refrigerated cabinet failure.

12. ATTACHMENTS

No.			Page
1	Electrical diagram	412100333000	23
2	Declaration of conformity		24

Attachment 1

Electrical diagram (code 412100333000)

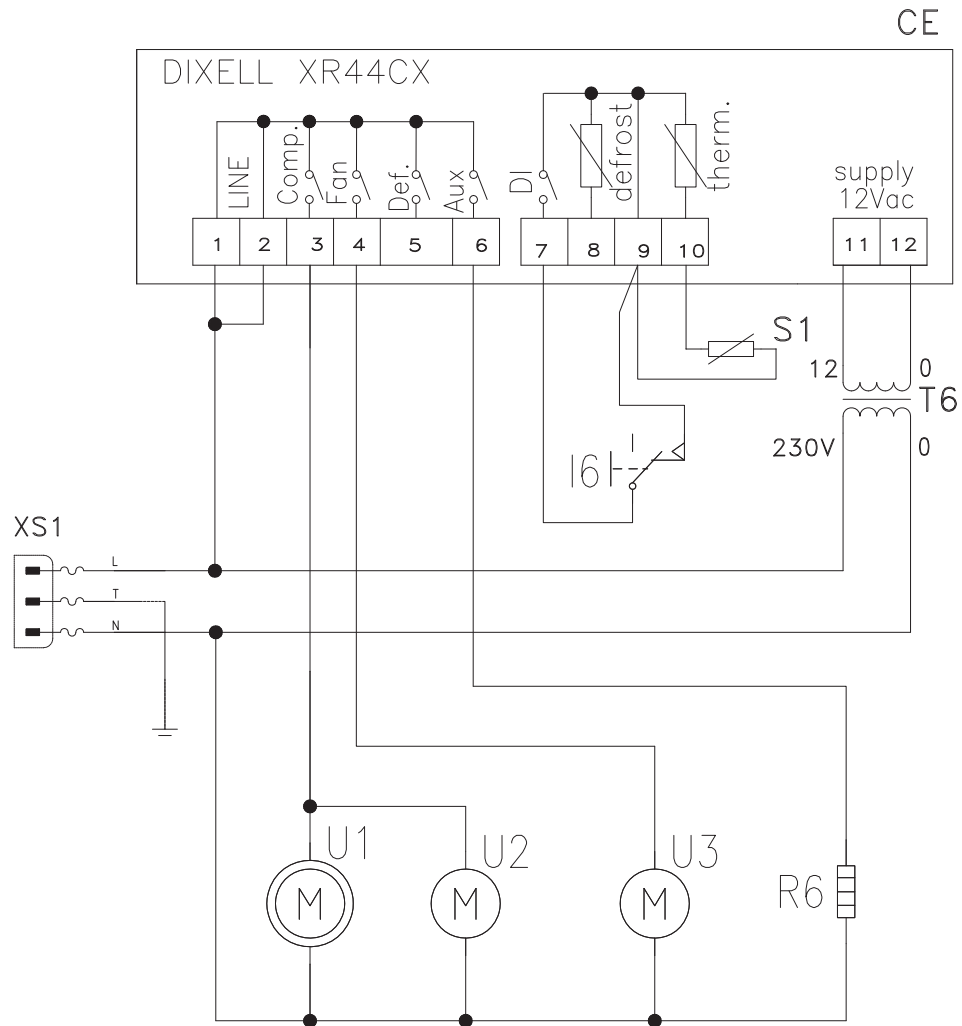

CE	Electronic control unit
I6	Microswitch
R6	Door perimeter heating resistor
S1	Temperature probe
T6	Transformer
U1	Compressor
U2	Condenser fan
U3	Evaporator fan
XS1	Power supply cable

Attachment 2

DECLARATION OF CONFORMITY

We: **ISA S.r.l.**

Via del Lavoro, 5 - 06083 - Bastia Umbra (PG)

under our exclusive responsibility declare that the product:

Product: **LABOR NEW**
Serial no.: XXXXXXXXXXXXXXXXXXXX

To which this declaration refers, is compliant with the following:

SAFETY OF MACHINERY

General Electrical Safety Standard EN 60335-1/Ed.2002+Modifications A11:2004,A12:2006,A2:2006,A13:2008 Special Safety Requirements for Commercial Refrigeration Appliances EN 60335-2-89/Ed. 2010 Standard for the Measurement of Electromagnetic Fields (EMF) of Electrical Appliances EN 62233:2008 Directive 2006/95/EC of the European Parliament and the Council of 12th December 2006 on the harmonisation of the Laws of Member States relating to electrical equipment for use within certain voltage limits. EN 62471/Ed.2009 Photobiological safety lamps and lamp systems

ELECTROMAGNETIC COMPATIBILITY (EMC)

Limits and measurement methods for radio interference characteristics of household appliances and similar motor-operated and heating appliances, tools, electrical appliances and similar apparatus EN 55014-1 (valid until 2009: Ed.2000+Amendments A1:2001, A2:2002 - or: Ed.2006)

Minimum requirements for household appliances, tools and similar electrical appliances. EN 55014-2 (Ed.1997+Amendment A1:2001) Part 3: Limits - Section 2: Limits for harmonic current emissions (equipment input current=16A per phase)

EN61000-3-2 (valid until 2009:Ed.2000+Modification A2:2005-or:Ed.2006) Part 3: Limits - Section 3: Limitation of voltage fluctuations and flicker in low-voltage power supply systems for equipment with rated current=16A

EN61000-3-3 (Ed.1995+Modifications A1:2001,A2:2005) Part 4: Testing and measurement techniques Section 2: Electrostatic discharge immunity test EN61000-4-2 (Ed.1995) Part 4: Testing and measurement techniques Section 4: Electrical fast transient/burst immunity test EN61000-4-4 (Ed.1995)

PRESSURE EQUIPMENT DIRECTIVE (PED) 97/23/EC

As the equipment falls into a class lower than I, it is excluded from the PED's application field (art.1 par.3.6)

FOOD COMPATIBILITY

Regulation (EC) No.1935/2004 of the European Parliament and of the Council of 27th October 2004 Regulation (EC) No.2023/2006 of the Commission of 22nd December Directive 2008/39/EC of the Commission of 6th March 2008 Directive 2007/19/EC of the Commission of 30th March 2007 Directive 2005/79/EC of the Commission of 18th November 2005 Directive 2004/19/EC of the Commission of 10th March 2004 Directive 2004/1/EC of the Commission of 6th January 2004 Regulation (EU) 10/2011 of the Commission of 14th January 2011

ROHS AND WEEE

Directive 2002/95/EC of the European Parliament and of the Council of 27th January 2003

Directive 2002/96/EC of the European Parliament and of the Council of 27th January 2003

REACH

Regulation (EC) No.1907/2006 of the European Parliament and of the Council of 18th December 2006 on the recording, assessing, authorising and restricting of chemical substances (REACH), implemented by a European agency for chemical substances, modifying Directive 1999/45/EC and repeals Regulation (EEC) no. 793/93 of the Council and Regulation (EC) no. 1488/94 of the Commission 91/155/EEC, 93/105/EC and 2000/21/EC

SUBSTANCES REDUCING THE OZONE LAYER

Regulation (EC) No.1005/2009 of 16th September 2009 (G.U.U.E 31/10/2009 L286)

According to the requirements set by Directives: 2006/95/EC, 2004/108/EC, 2006/42/EC, 97/23/EC

The person authorised to institute the Technical File is Mr. **Maurizio Minelli** (Technical Department Manager)
Via del Lavoro 5 - 06083 Bastia Umbra (PG)

Bastia Umbra: **24 / 07 / 2012**
(place and date of issue)

Maurizio Minelli

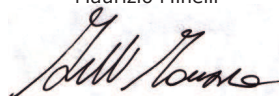



Idee che lavorano con te

ISA S.r.l.

Via del Lavoro, 5
06083 Bastia Umbra
Perugia - Italy
Tel. +39 075 80171
Fax +39 075 8000900

www.isaitaly.com